







**PARTS LIST**

No.	DESCRIPTION	IMAGE	Q'TY
P1	SEAT CUSHION		1
P2	LEFT BACK CUSHION		1
P3	RIGHT BACK CUSHION		1
P4	CONSOLE BACK CUSHION		1
P5	TRANSFORMER		1
P6	TRANSFORMER		1

**NOTE:** PO# is located at the front side of each carton. Please be prepared to provide this # should any claim be necessary.

**CAUTION:** Item is heavy. Assembly should be performed by two people.

1

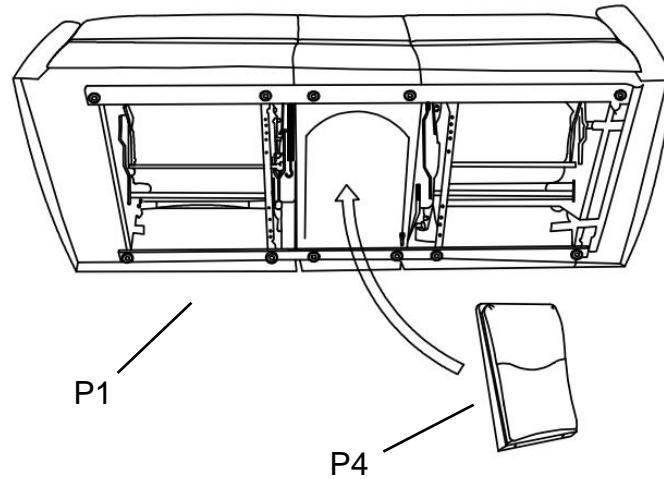

3

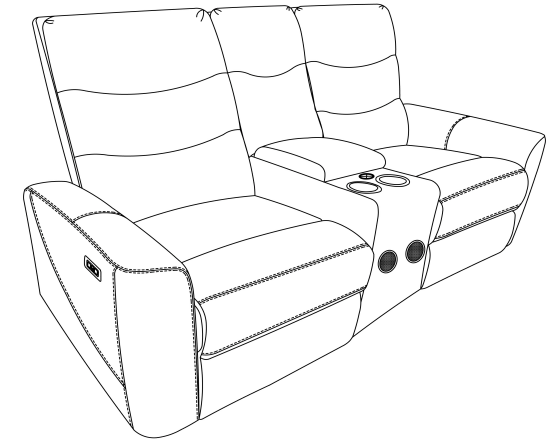

2

