

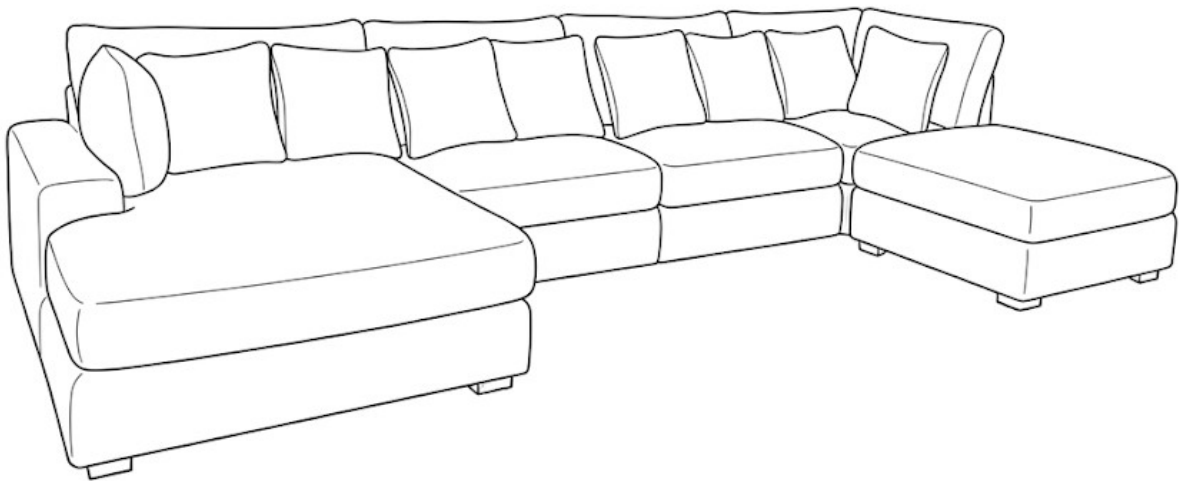

LV25624/LV25724/LV25824

SECTIONAL SOFA
ASSEMBLY INSTRUCTIONS









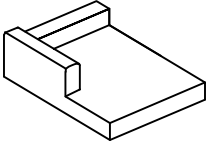

ASSEMBLY TIPS:

- 1.Remove hardware from box and sort by size.
- 2.Pleases check to see that all hardware and parts are present prior to start of assembly.
- 3.Please follow attached instruction in the same sequence as numbered to assure fast & easy assembly.

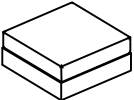

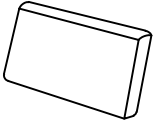
warming:

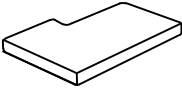
- 1.Don't attempt to repair or modify parts that are broken or defective. Pleases contact the store immediately.
- 2.This product is for home use only and not intended for commercial establishment.

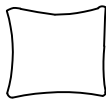
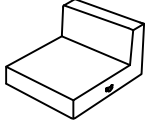
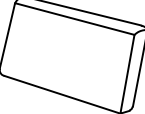
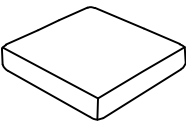
<u>PARTS IDENTIFICATION</u>				<u>HARDWARE LIST</u>			
PART	DRAWING	DESCRIPTION	QTY	PART	DRAWING	DESCRIPTION	QTY
#1		LHF-CHAISE CHAIR	1PC	A		Bolt Ø 5/16"x70mm	20PCS
#2		OTTOMAN	1PC	B		Ø5/16	20PCS
#3		BACKREST PILLOW LHF CHAISE	1PC	C		Ø5/16x19mm	20PCS
#4		SEAT LHF-CHAISE	1PC	D		Key 25*70mm	1PCS
#5		PILLOW LHF-CHAISE	3PCS				
#6		ARMLESS CHAIR	2PCS				
#7		BACKREST PILLOW ARMLESS CHAIR	2PCS				
#8		SEAT ARMLESS CHAIR	2PCS				

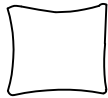
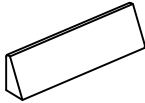
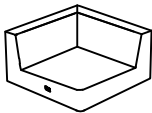
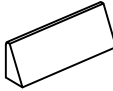
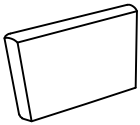
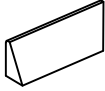
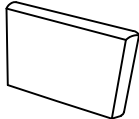
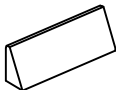
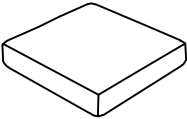
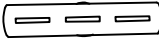
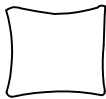
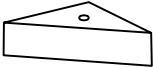
<u>PARTS IDENTIFICATION</u>				<u>PARTS IDENTIFICATION</u>			
PART	DRAWING	DESCRIPTION	QTY	PART	DRAWING	DESCRIPTION	QTY
#9		PILLOW ARMLESS CHAIR	4PCS	#15		HEADREST LHF CHAISE	1PC
#10		CORNER/-CHAIR	1PC	#16		HEADREST ARMLESS CHAIR	2PCS
#11		BACKREST PILLOW CORNER CHAIR	1PC	#17		HEADREST CORNER-CHAIR	1PC
#12		BACKREST PILLOW CORNER CHAIR	1PC	#18		HEADREST CORNER-CHAIR	1PC
#13		SEAT -CORNER CHAIR	1PC	#19		Carcase connector	10PCS
#14		PILLOW CORNER-CHAIR	2PCS	#20		LEG	20PCS

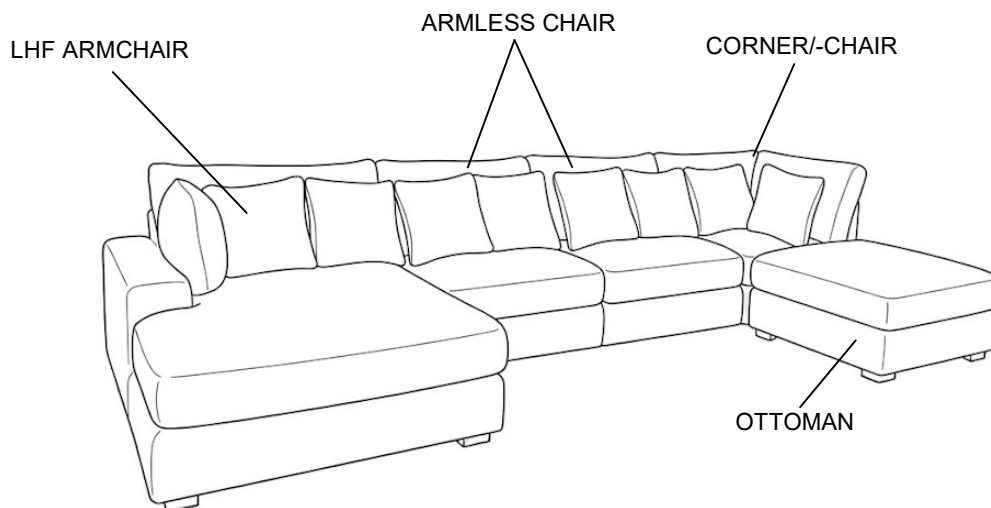

STEP 1

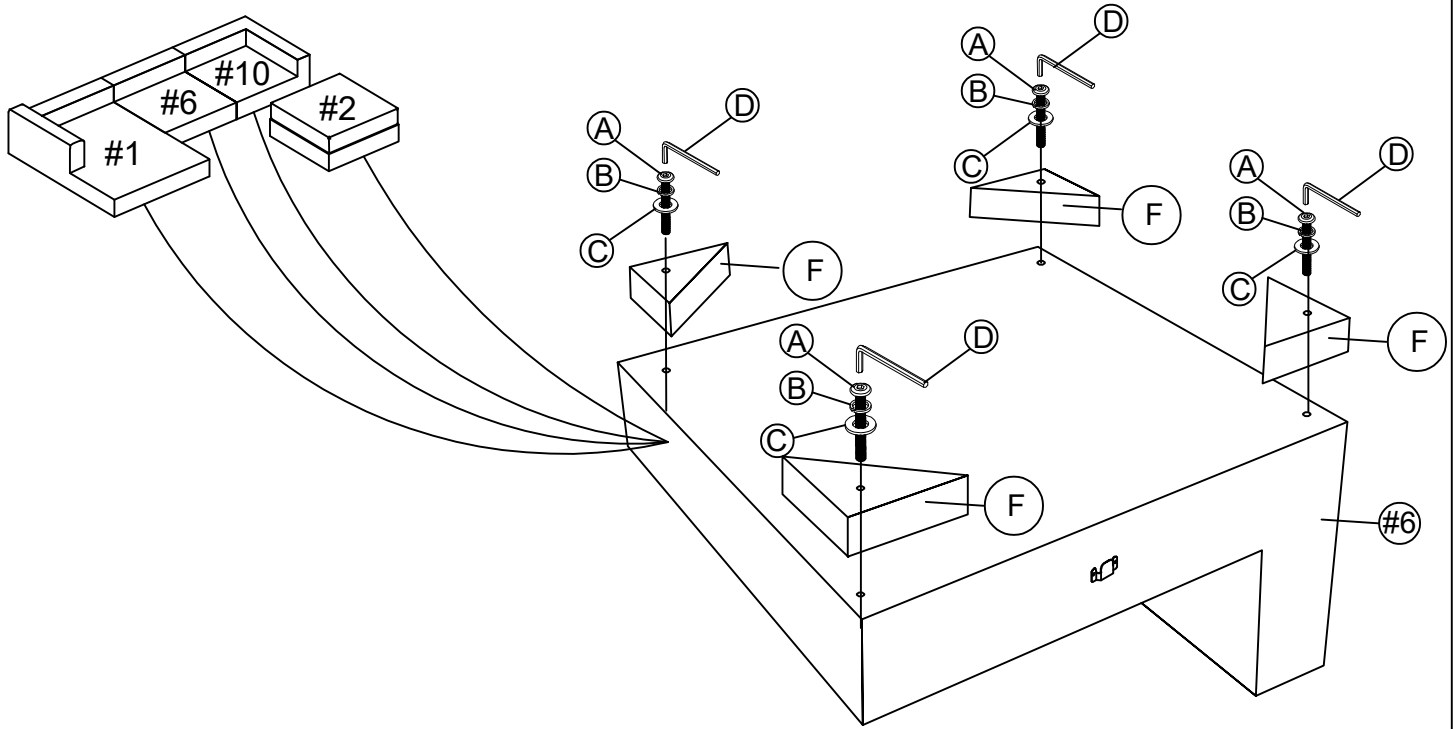

STEP 2

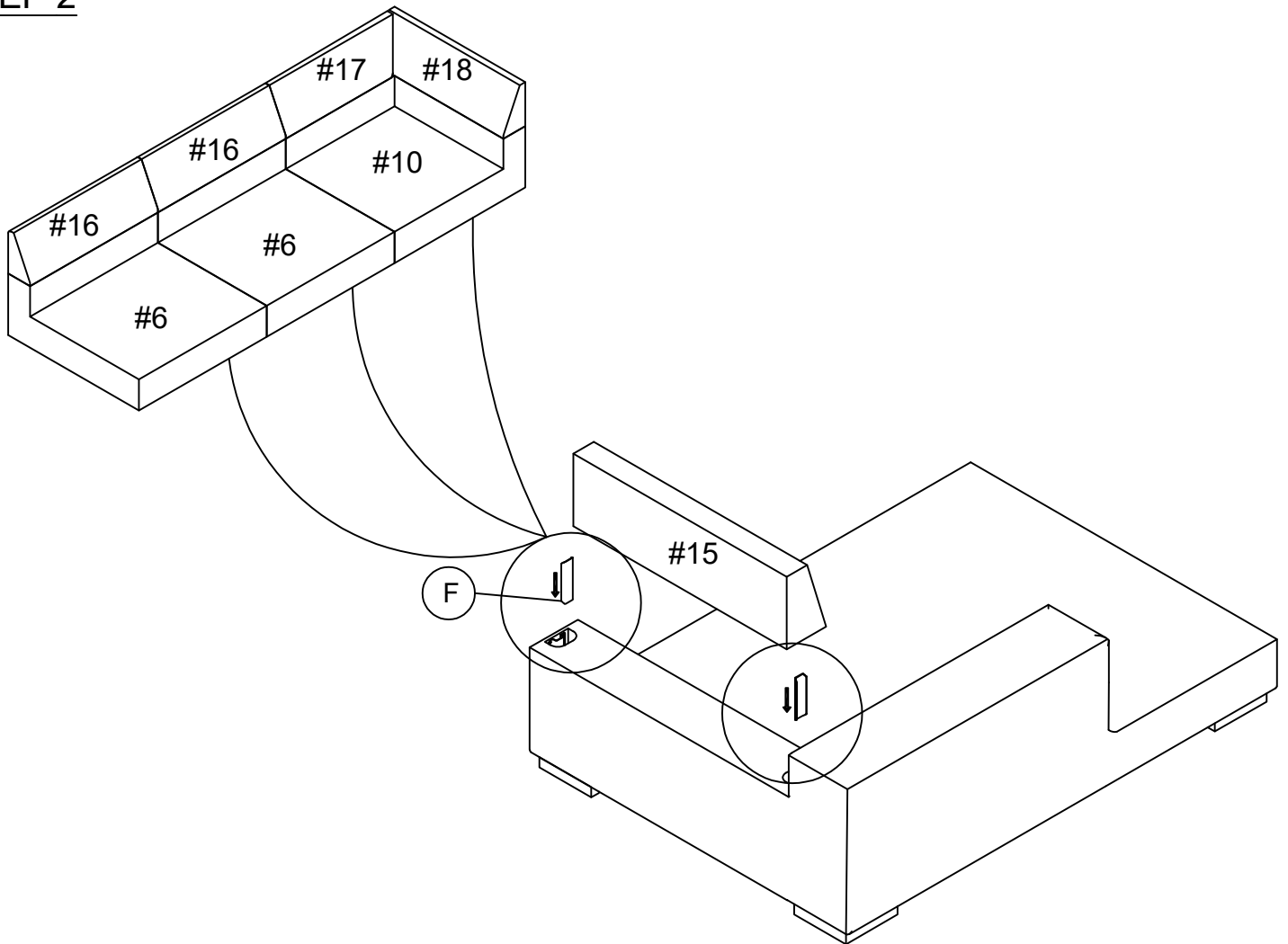

STEP 3

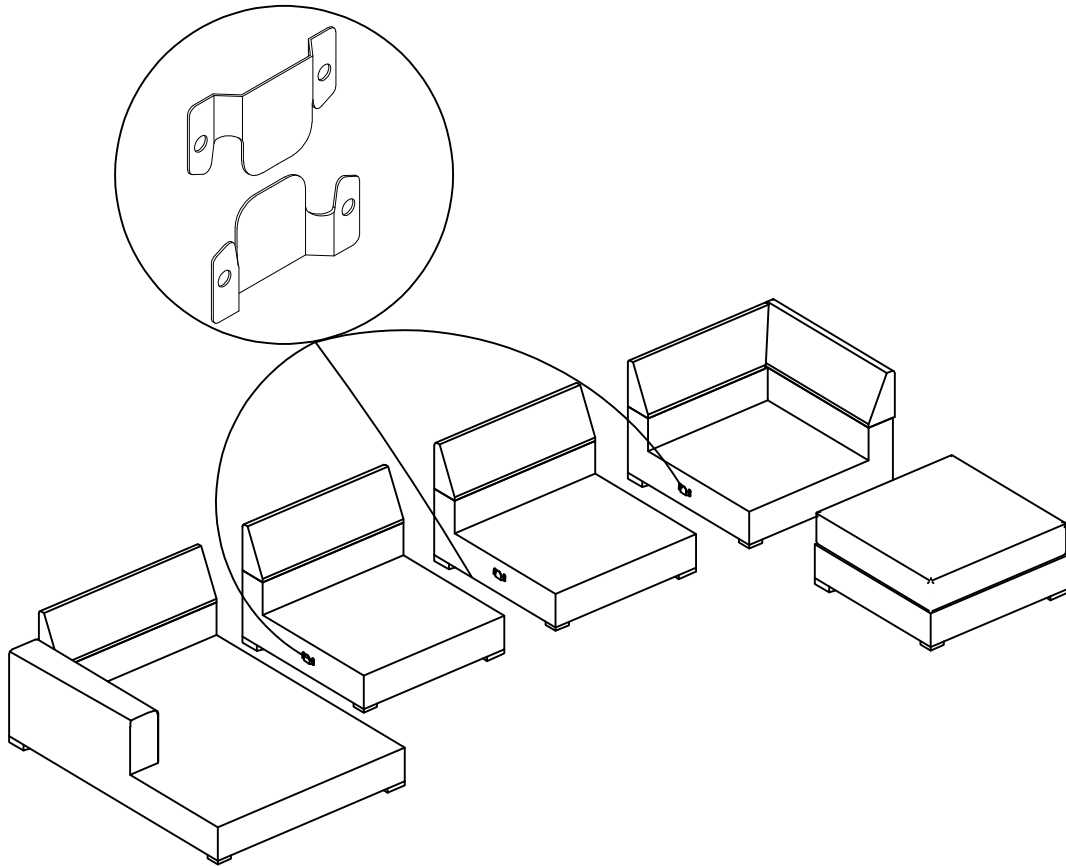

STEP 4

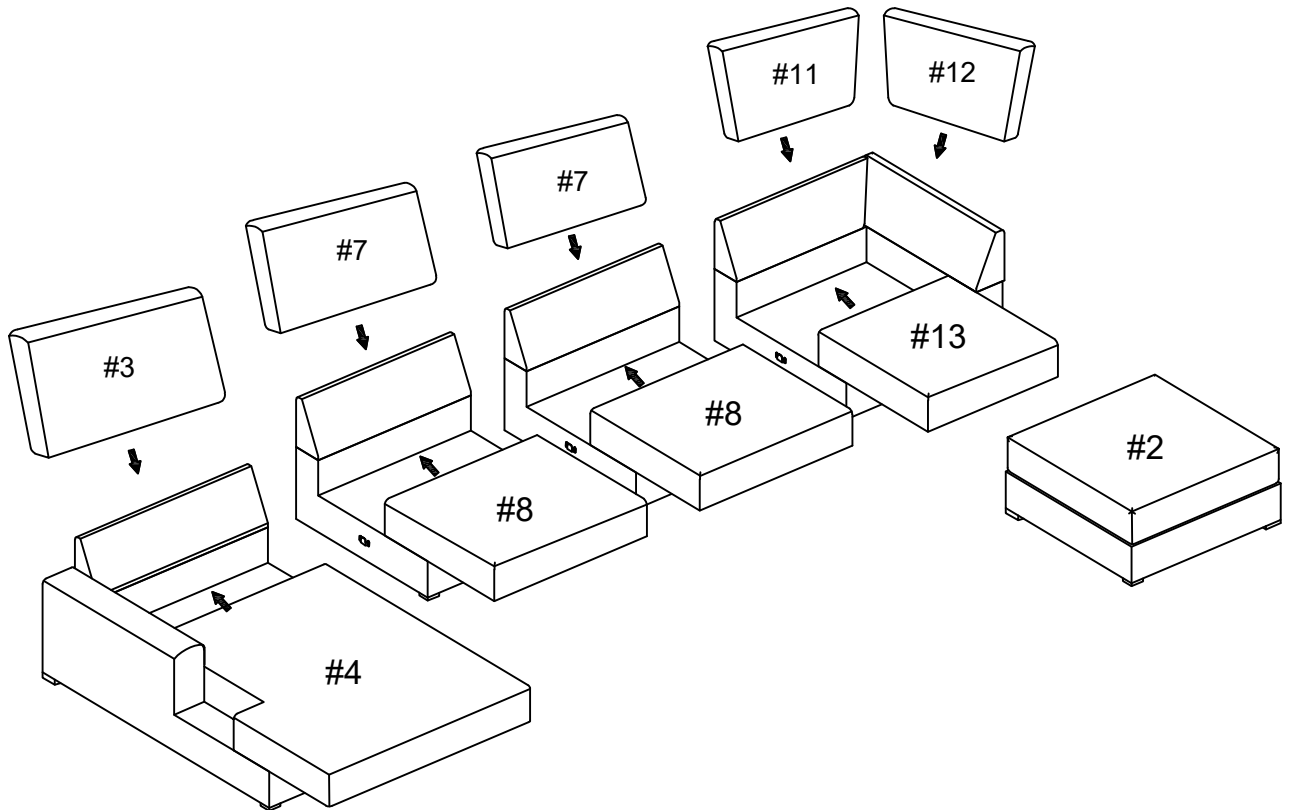

STEP 5

