







# ASSEMBLY INSTRUCTIONS

ITEM NUMBER: AV25646

DESCRIPTION: COFFEE TABLE

Thank you for purchasing this quality product. Please read instructions carefully prior to assembly. Check carefully for small parts which may have come loose during transportation inside all the boxes. Remove from boxes and place all parts and components on soft surface such as carpet. Blanket or furniture pad. Identify and verify all parts and hardware as specified below.

PART LIST				HARDWARE LIST			
A		TABLE TOP	1 PC	1		FLAT WASHER Ø5/16 x 3/4"	8 PCS
B		LEGS	4 PCS	2		WASHER Ø5/16 x 1/2"	8 PCS
				3		BOLT Ø5/16 x 3 1/4"	8 PCS
				4		ALLEN KEY Ø5/16 x 3 1/4"	1 PC

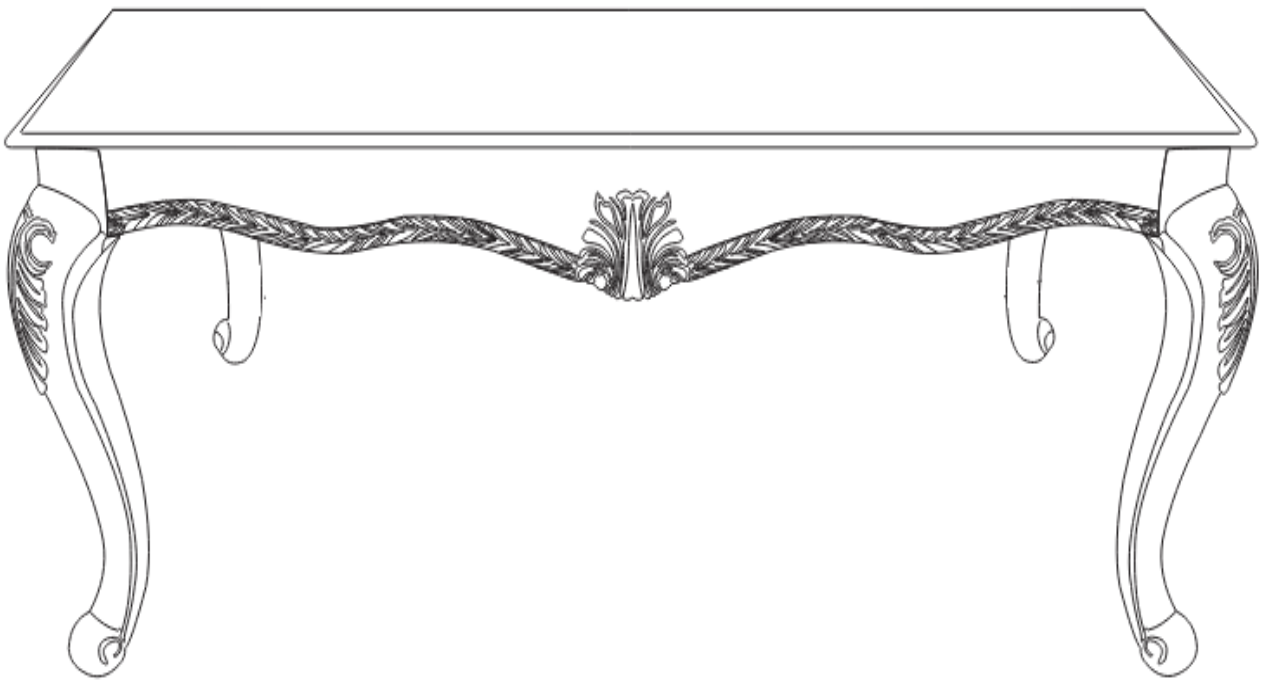

**ASSEMBLY TIPS:**

1. Remove hardware from box and sort by size.
2. Please check to see that all hardware and parts are present prior to start of assembly.
3. Please follow attached instructions in the same sequence as numbered to assure fast & easy assembly.

**WARNING!**

1. Don't attempt to repair or modify parts that are broken or defective. Please contact the store immediately.
2. This product is for home use only and not intended for commercial establishments.
3. Minimum of 2 people are required for assembly.

**\*How to assemble:**

**STEP 1:** Place the wood table top (A) face down on a clean and soft surface. Assemble the Legs (B) to the wood table top (A) by using Allen key (4) with hardware, 1, 2, and 3.

\*Do not tighten the screw\*

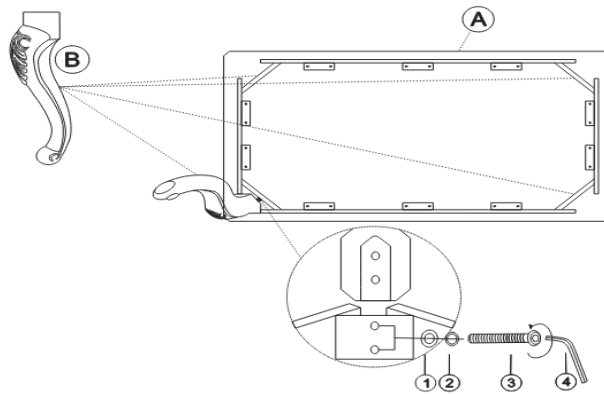

**COMPLETE :** To level the table, place the table up right on a flat surface then tighten all screws by using Allen Key(4)

