







MODEL: DM25551

Important note: - Place all wooden part on a clean and smooth surface such as rug or carpet to avoid the part from being scratch.
 - Please follow the assembly instruction step by step.
 - Do not tighten all screw until the chair is fully set-up.

ASSEMBLY INSTRUCTION

No	Hardware List	Qty.
A	JCBC M6 x 80mm 	8 pcs
B	JCBC M6 x 60mm 	8 pcs
C	JCBC M6 x 35mm 	4 pcs
D	M6 Spring Washer 	20 pcs
E	M6 Flat Washer 	20 pcs
F	CSK M4 x 32mm 	12 pcs
G	Allen Key M4 	1 pc

No	Part List	Qty.
1	Backrest	2 pcs
2	Box Seat	2 pcs
3	Front Leg	4 pcs
4	Wooden Slat / Cushion	2 pcs

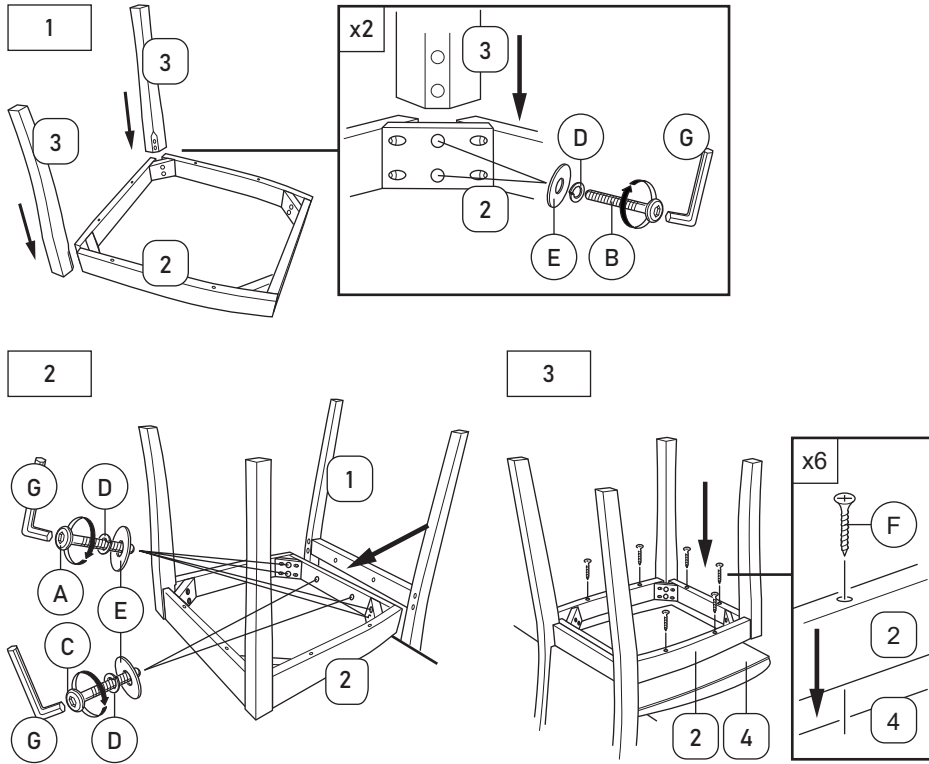



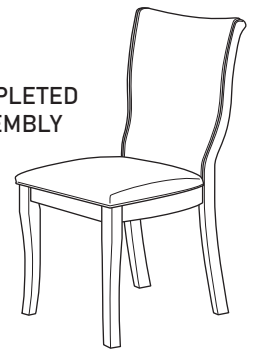



COMPLETED ASSEMBLY



MODEL: DM25551

Important note: - Place all wooden part on a clean and smooth surface such as rug or carpet to avoid the part from being scratch.
 - Please follow the assembly instruction step by step.
 - Do not tighten all screw until the chair is fully set-up.

ASSEMBLY INSTRUCTION

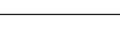
No	Hardware List	Qty.
A	JCBC M6 x 80mm 	8 pcs
B	JCBC M6 x 60mm 	8 pcs
C	JCBC M6 x 35mm 	4 pcs
D	M6 Spring Washer 	20 pcs
E	M6 Flat Washer 	20 pcs
F	CSK M4 x 32mm 	12 pcs
G	Allen Key M4 	1 pc

No	Part List	Qty.
1	Backrest	2 pcs
2	Box Seat	2 pcs
3	Front Leg	4 pcs
4	Wooden Slat / Cushion	2 pcs

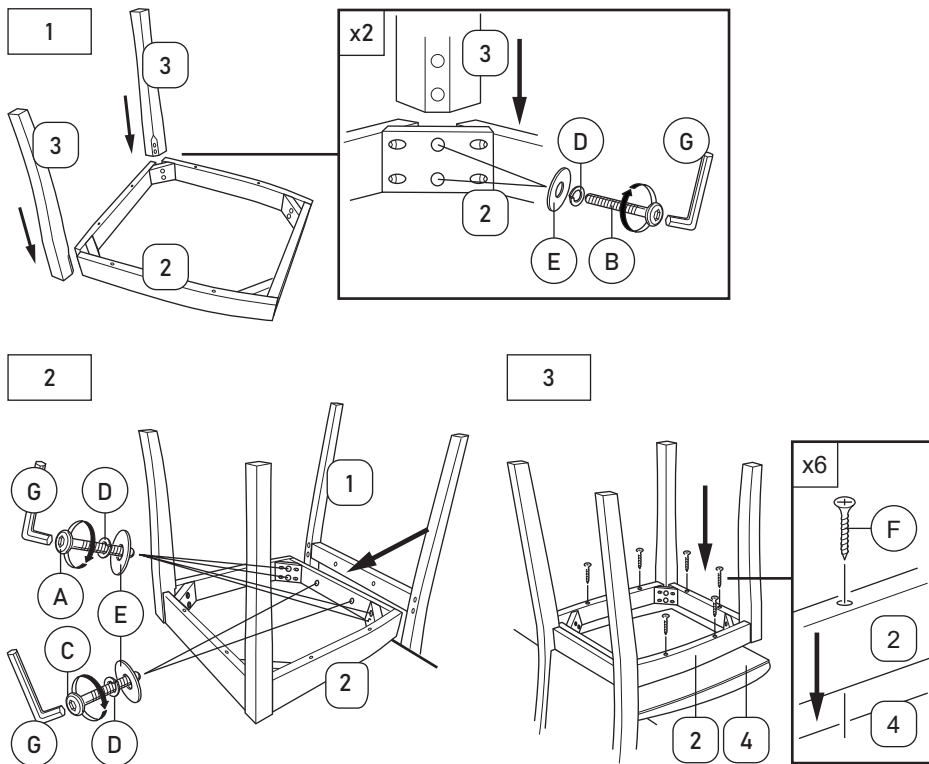

COMPLETED ASSEMBLY

