











ASSEMBLY INSTRUCTIONS

ITEM NUMBER: LV25646

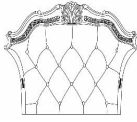
DESCRIPTION: CHAIR

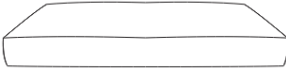
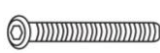
Thank you for purchasing this quality product. Please read instructions carefully prior to assembly. Check carefully for small parts which may have come loose during transportation inside all the boxes. Remove from boxes and place all parts and components on soft surface such as carpet. Blanket or furniture pad. Identify and verify all parts and hardware as specified below.

PART LIST				HARDWARE LIST			
A		SEAT FRAME	1 PC	1		FLAT WASHER Ø5/16 x 3/4"	10 PCS
B		LEFT ARM	1 PC	2		WASHER Ø5/16 x 1/2"	10 PCS
C		RIGHT ARM	1 PC	3		BOLT Ø5/16 x 2 1/4"	8 PCS
D		BACKREST	1 PC	4		ALLEN KEY Ø5/16 x 3 1/4"	1 PC
E		SEAT CUSHION	1 PC	5		BOLT Ø5/16 x 3 1/4"	2 PCS
F		LEG	4 PCS				

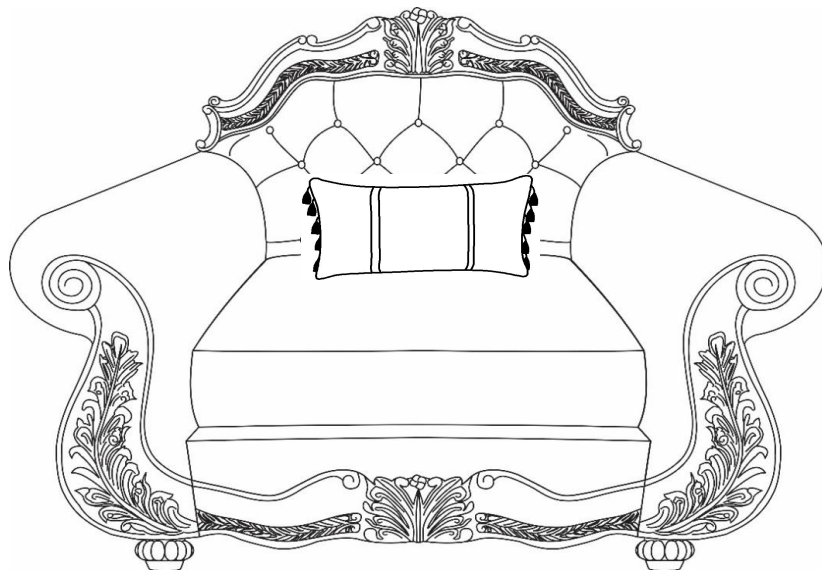

**ASSEMBLY TIPS:**

1. Remove hardware from box and sort by size.
2. Please check to see that all hardware and parts are present prior to start of assembly.
3. Please follow attached instructions in the same sequence as numbered to assure fast & easy assembly.

WARNING!

1. Don't attempt to repair or modify parts that are broken or defective. Please contact the store immediately.
2. This product is for home use only and not intended for commercial establishments.
3. Minimum of 2 people are required for assembly.

***How to assemble:**

STEP 1: Lay the seat frame (A) on its back side to reach the holes to secure the bolts for the arms. Assemble the LSF arm (B) and RSF arm (C) to the seat frame (A) using Allen Key (4) with hardware, 1, 2, and 3.

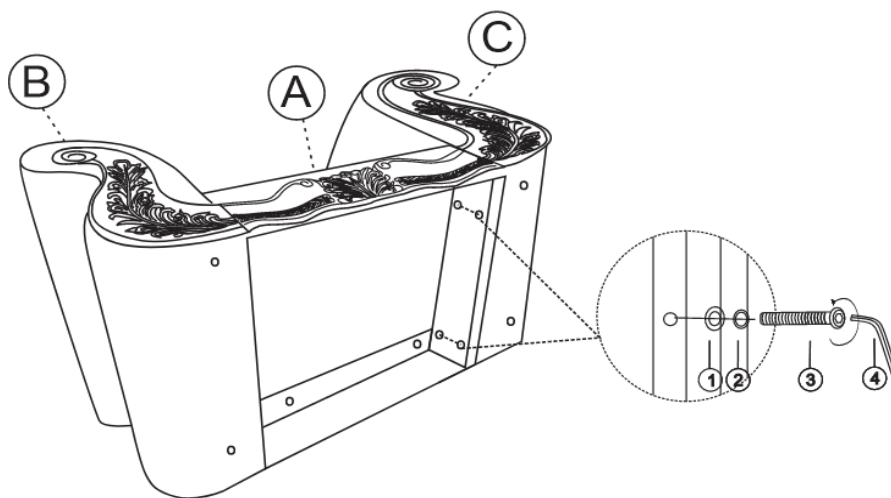

STEP 2: Align and install the legs (F) to the bottom of the arms (B & C)

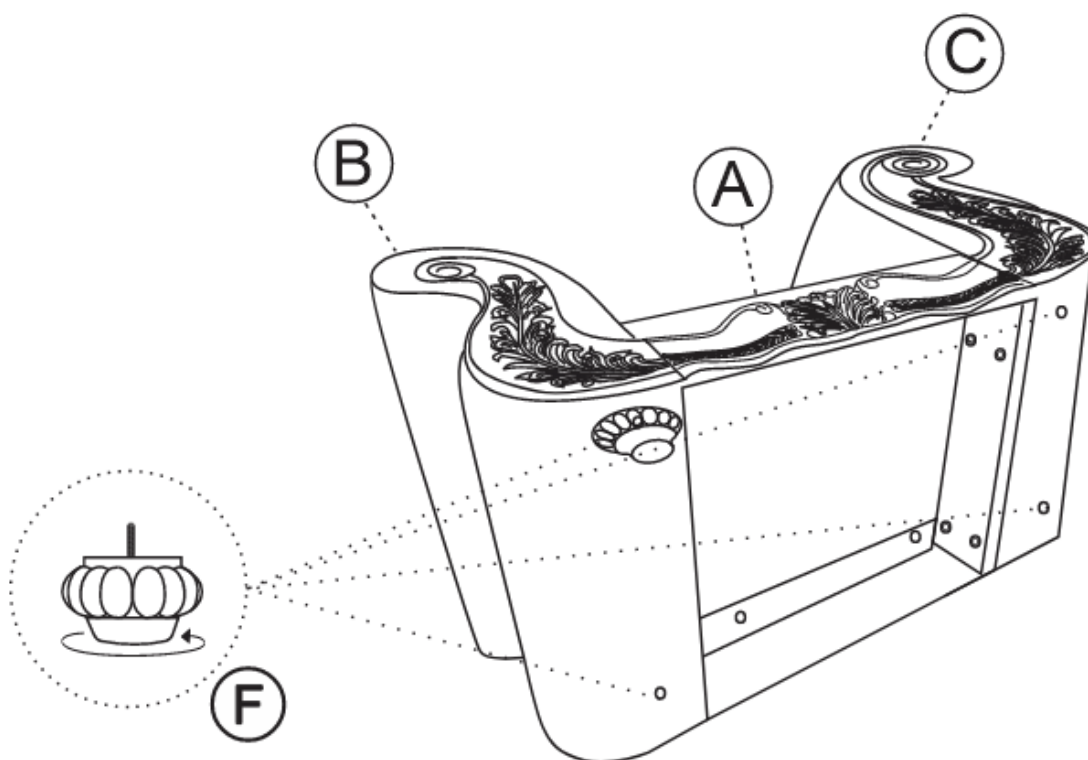

**ASSEMBLY TIPS:**

1. Remove hardware from box and sort by size.
2. Please check to see that all hardware and parts are present prior to start of assembly.
3. Please follow attached instructions in the same sequence as numbered to assure fast & easy assembly.

WARNING!

1. Don't attempt to repair or modify parts that are broken or defective. Please contact the store immediately.
2. This product is for home use only and not intended for commercial establishments.
3. Minimum of 2 people are required for assembly.

STEP 3: Place the frame up right and install the backrest (D) to the LSF arm (B) and RSF arm (C) by sliding the brackets all the way until it is secured.

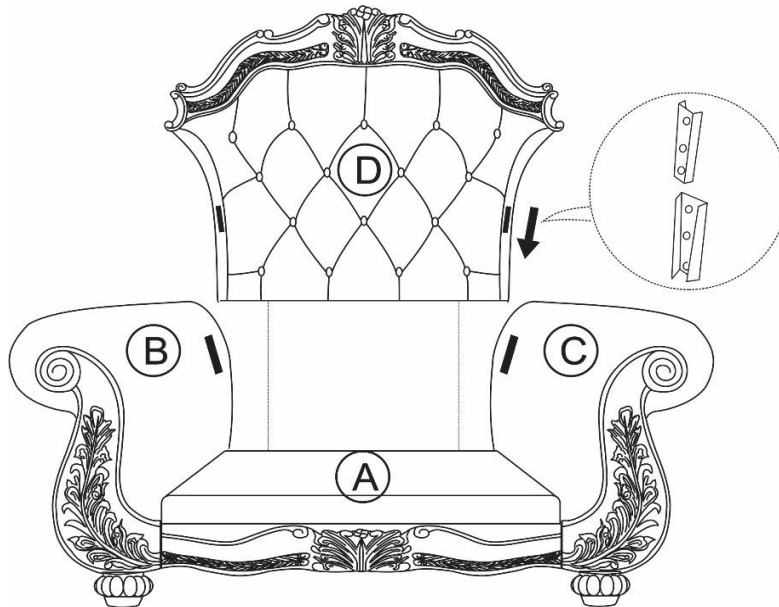

STEP 4: Place the chair on its back on a clean and soft surface and secure the bolts for the chair back (D) at bottom the seat frame (A) by using the Allen key (4) with hardware 1,2 and 5.

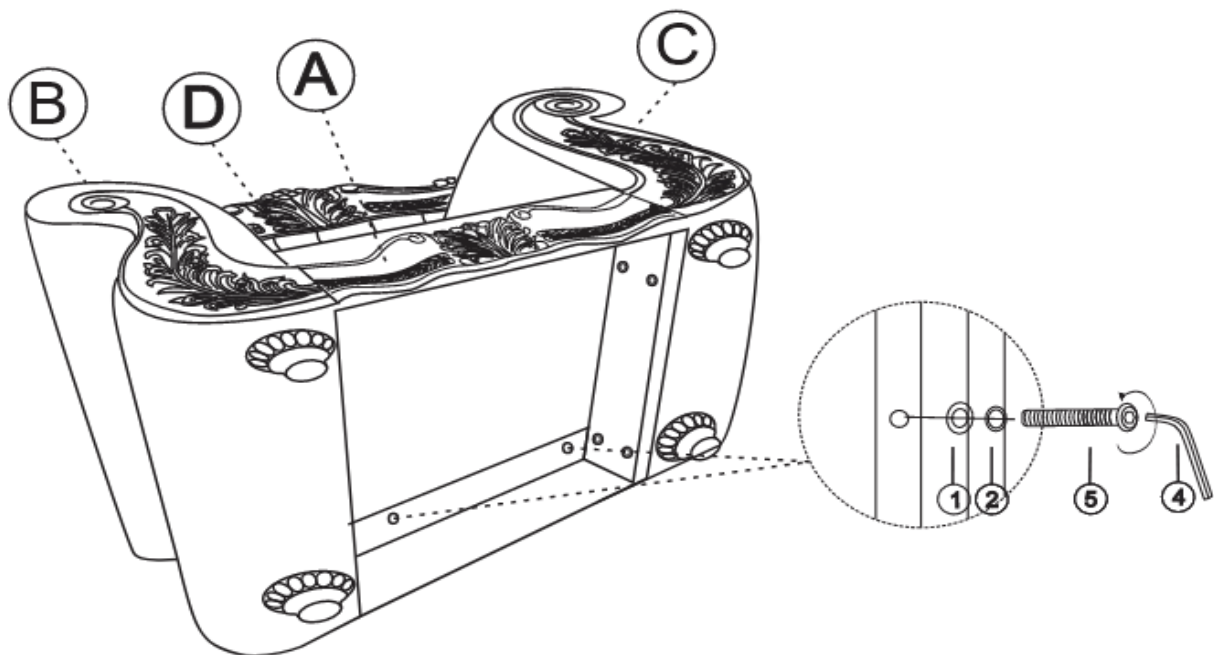

**ASSEMBLY TIPS:**

1. Remove hardware from box and sort by size.
2. Please check to see that all hardware and parts are present prior to start of assembly.
3. Please follow attached instructions in the same sequence as numbered to assure fast & easy assembly.

WARNING!

1. Don't attempt to repair or modify parts that are broken or defective. Please contact the store immediately.
2. This product is for home use only and not intended for commercial establishments.
3. Minimum of 2 people are required for assembly.

STEP 5: Place the frame up right and place the seat cushion (E) to the seat frame.

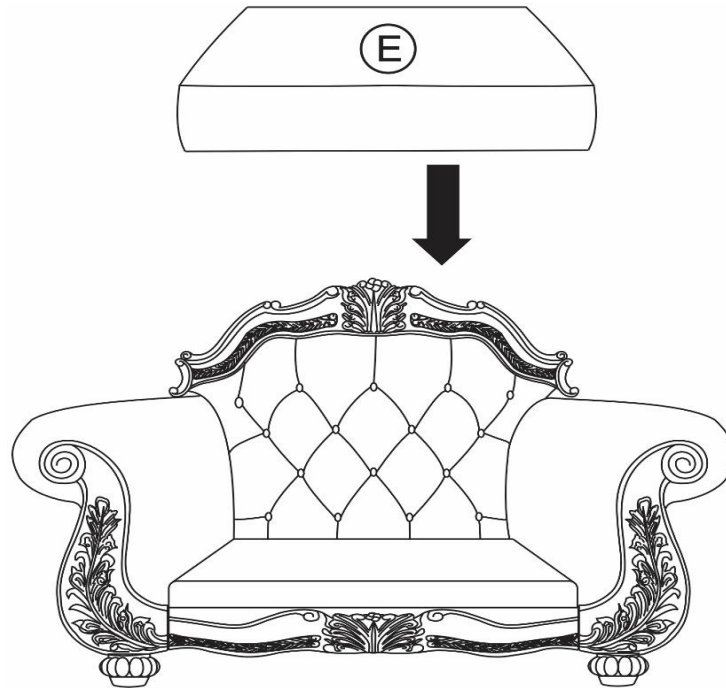

STEP 6: COMPLETE

