

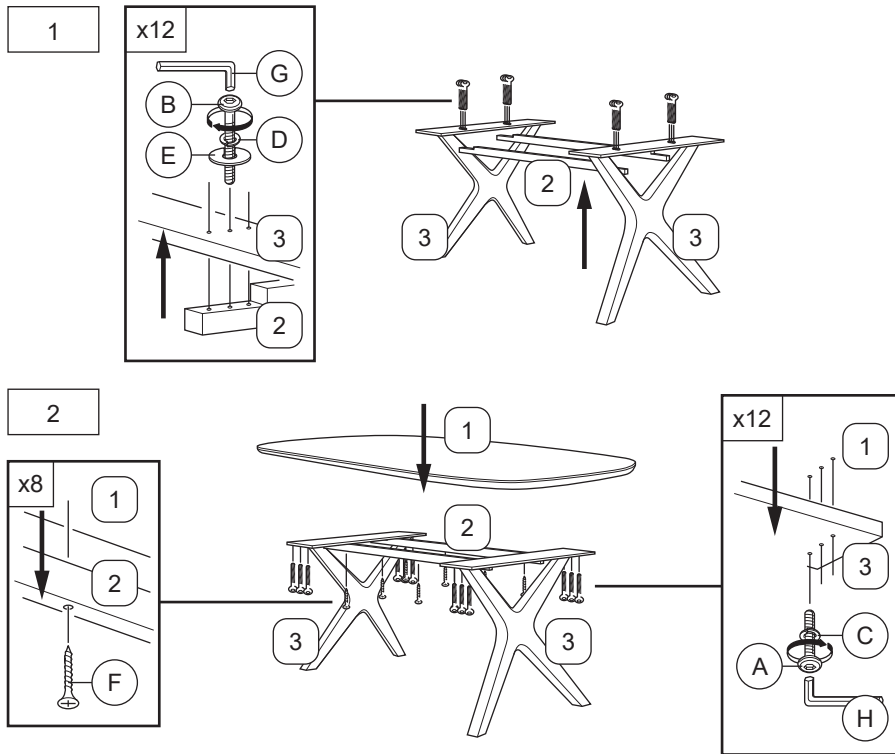





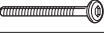

Model: DM25607

Important note: - Place all wooden part on a clean and smooth surface such as rug or carpet to avoid the part from being scratch.
 - Please follow the assembly instruction step by step.
 - Do not tighten all screw until the table is fully set-up.



ASSEMBLY INSTRUCTION

No	Hardware List	Qty.
A	JCBB M8 x 35mm 	12 pcs
B	JCBC M6 x 40mm 	12 pcs
C	M8 Spring Washer 	12 pcs
D	M6 Spring Washer 	12 pcs
E	M6 Flat Washer 	12 pcs
F	CSK M4 x 32mm 	8 pcs
G	Allen Key M4 	1 pc
H	Allen Key M5 	1 pc

No	Part List	Qty.
1	Table Top	1 pc
2	Table Support	2 pcs
3	Table Leg	2 pcs

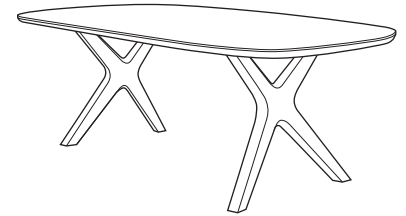





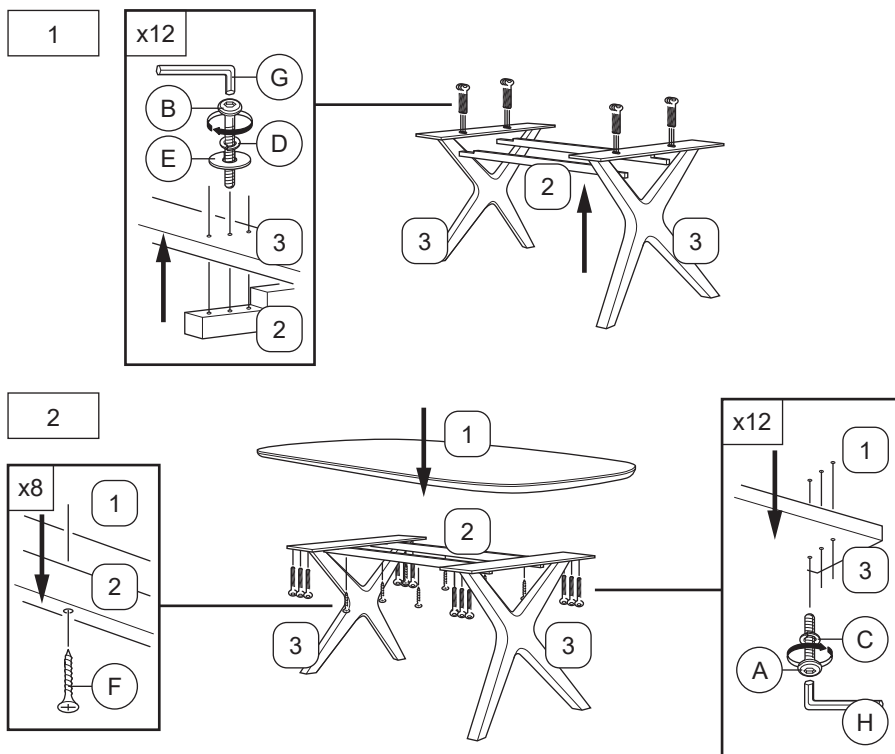

COMPLETED ASSEMBLY

Model: DM25607

Important note: - Place all wooden part on a clean and smooth surface such as rug or carpet to avoid the part from being scratch.
 - Please follow the assembly instruction step by step.
 - Do not tighten all screw until the table is fully set-up.



ASSEMBLY INSTRUCTION

No	Hardware List	Qty.
A	JCBB M8 x 35mm 	12 pcs
B	JCBC M6 x 40mm 	12 pcs
C	M8 Spring Washer 	12 pcs
D	M6 Spring Washer 	12 pcs
E	M6 Flat Washer 	12 pcs
F	CSK M4 x 32mm 	8 pcs
G	Allen Key M4 	1 pc
H	Allen Key M5 	1 pc

No	Part List	Qty.
1	Table Top	1 pc
2	Table Support	2 pcs
3	Table Leg	2 pcs

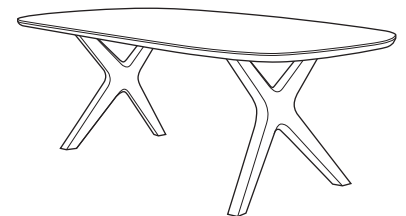

COMPLETED ASSEMBLY