

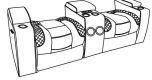





PARTS LIST

No.	DESCRIPTION	IMAGE	Q'TY
P1	SEAT BASE		1
P2	BACK CUSHIONS		2
P3	CONSOLE BACK CUSHION		1
P4	TRANSFORMER		2
P5	Y CABLE		1
P6	SCREWS		2

NOTE: PO# is located at the front side of each carton. Please be prepared to provide this # should any claim be necessary.

CAUTION: Item is heavy. Assembly should be performed by two people.

1

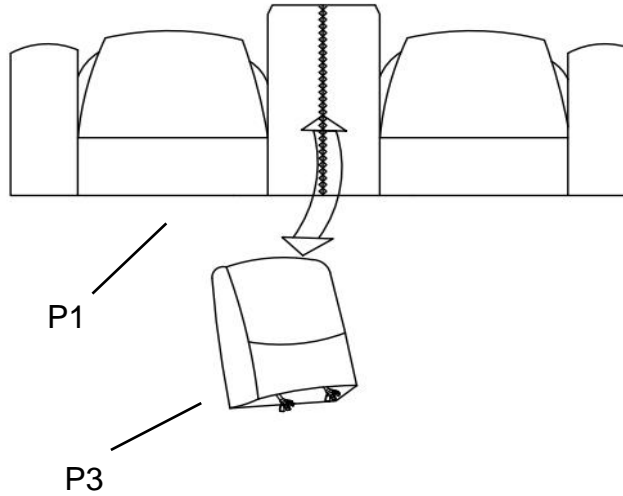

3

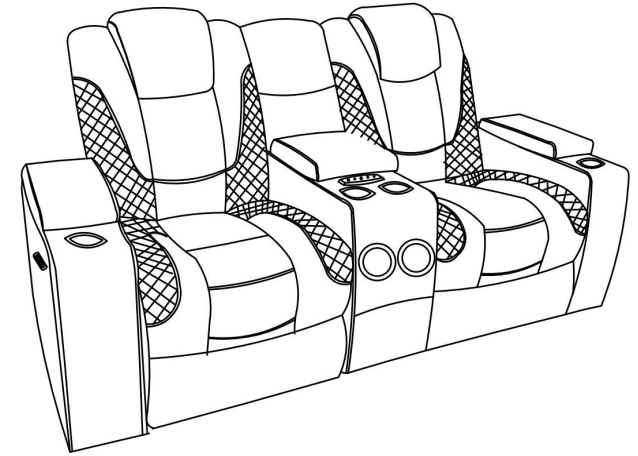

2

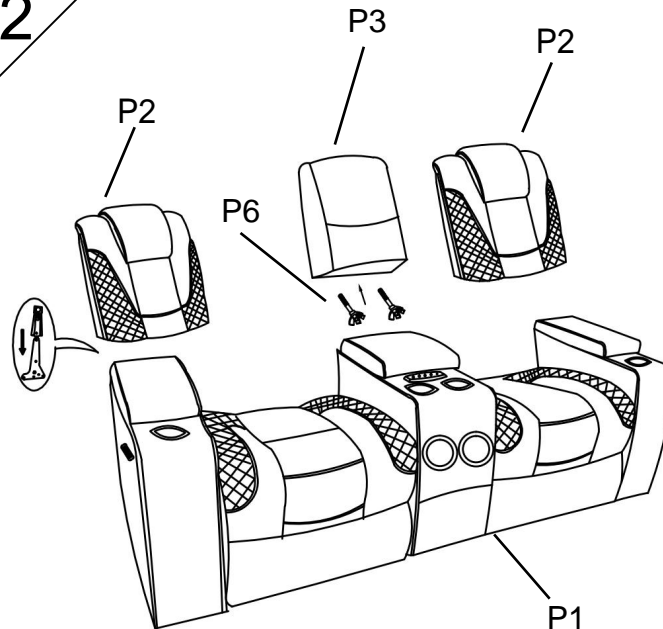

4

