



MOLLAI
COLLECTION

BV23277-DR/MR

DRESSER&MIRROR

ASSEMBLY INSTRUCTIONS

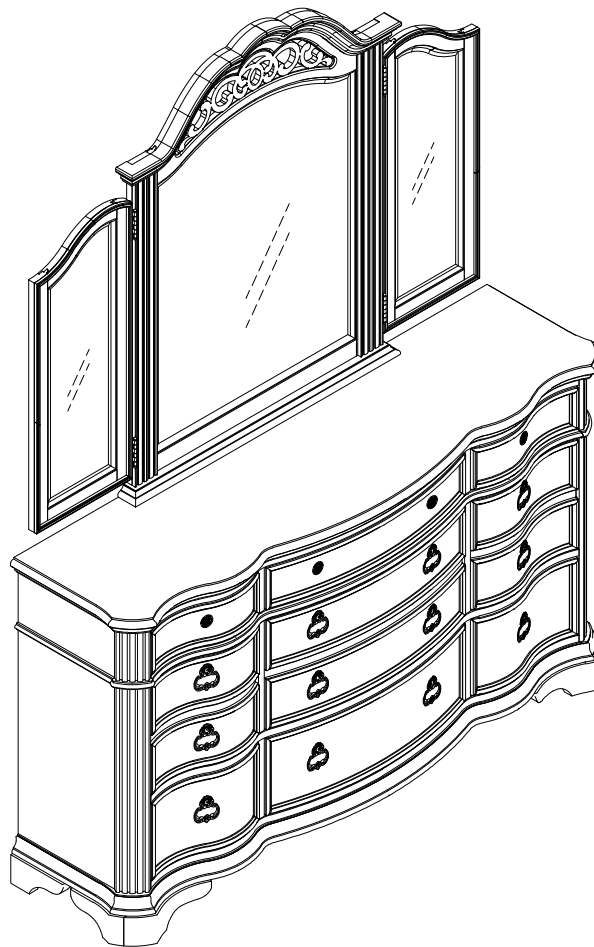

ASSEMBLY TIPS:





1. Remove hardware from box and sort by size.
2. Please check to see that all hardware and parts are present prior to start of assembly.
3. Please follow attached instructions in the same sequence as numbered to assure fast & easy assembly.

Warning!



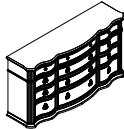



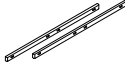

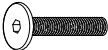

1. Don't attempt to repair or modify parts that are broken or defective. Please contact the store immediately.
2. This product is for home use only and not intended for commercial establishment.

PARTS IDENTIFICATION

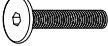
A		Dresser	1PC
B		Front legs	2PCS
C		Back legs	2PCS
D		Support leg	1PC
E		Mirror	1PC
F		Support rail	2PCS

HARDWARE IDENTIFICATION

1		Bolt 5/16"*2"	4PCS
2		Lock washer 5/16"	4PCS
3		Flat washer 5/16"	4PCS
4		Allen wrench 5MM	1PC
5		Bolt 1/4"*2"	8PCS
6		Lock washer 1/4"	8PCS
7		Flat washer 1/4"	8PCS
8		Allen wrench 4MM	1PC

STEP 1.

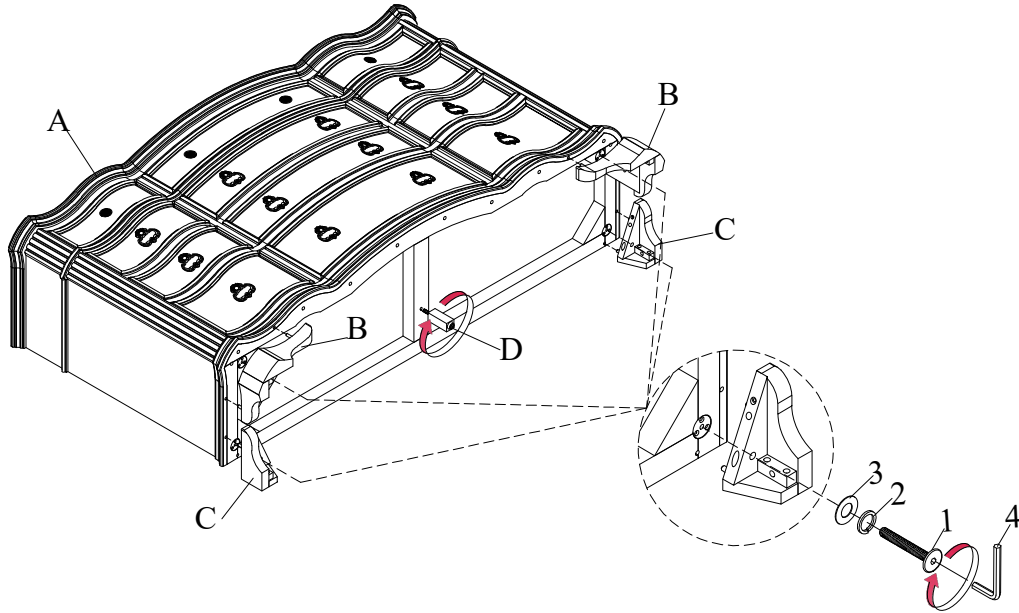

STEP 2.

