

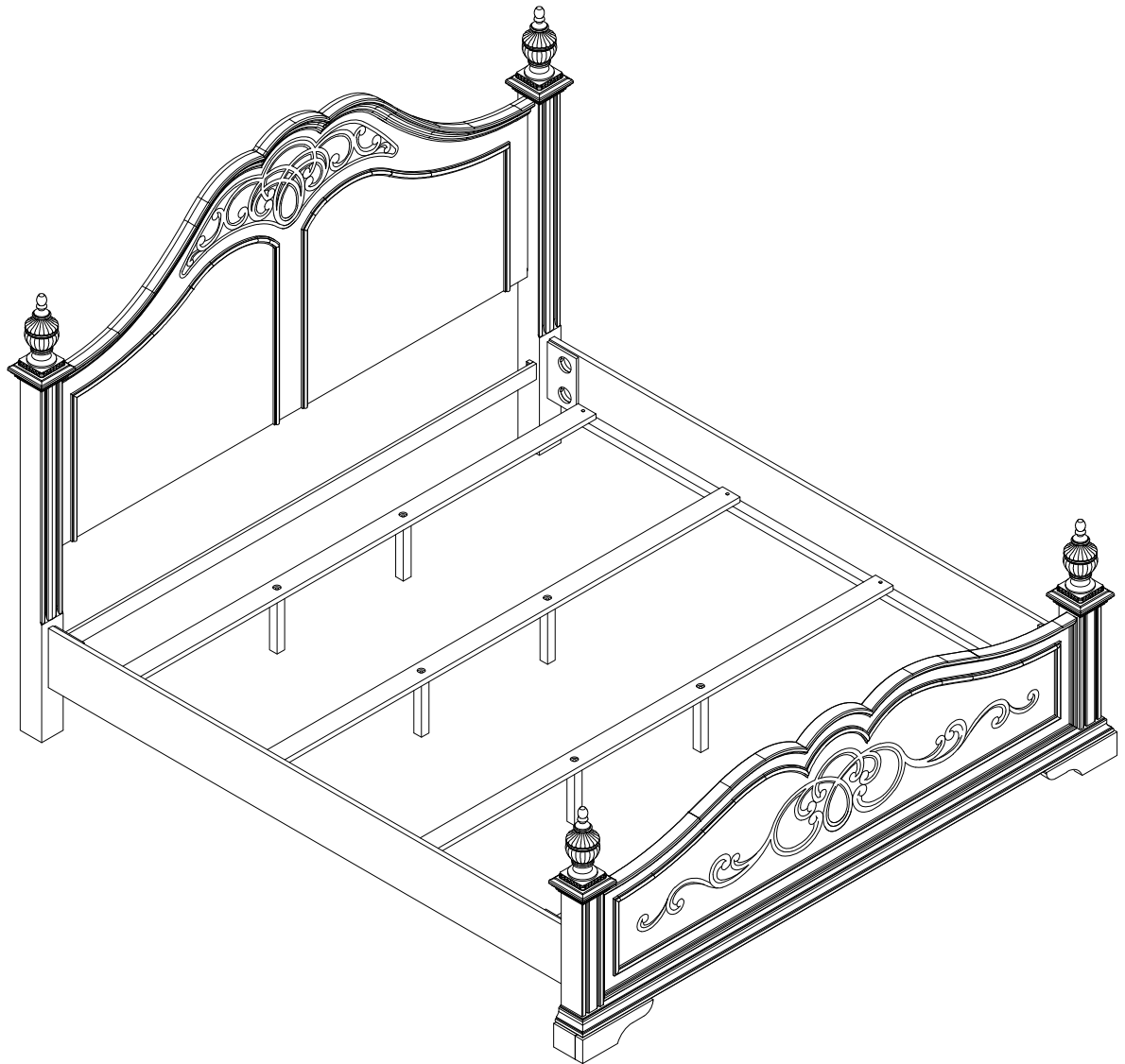

MOLLAI
COLLECTION

BV23277-EK
E KING BED

ASSEMBLY INSTRUCTIONS



ASSEMBLY TIPS:







1. Remove hardware from box and sort by size.
2. Please check to see that all hardware and parts are present prior to start of assembly.
3. Please follow attached instructions in the same sequence as numbered to assure fast & easy assembly.

Warning!

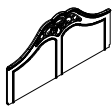

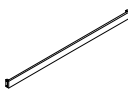

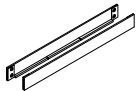





1. Don't attempt to repair or modify parts that are broken or defective. Please contact the store immediately.
2. This product is for home use only and not intended for commercial establishment.

PARTS IDENTIFICATION

A		Headboard	1PC
B		H/Board Post (R/ L)	2PCS
C		H/Board Post Final	4PCS
D		Bottom Rail	1PC
E		Footboard	1PC
F		Footboard Leg	2PCS
G		Bed rail	2PCS
H		Bed slat	4PCS
K		Center support with leveler	8PCS

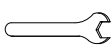
HARDWARE IDENTIFICATION

1		Bolt:5/16"	10PCS
2		Lock washer:5/16"	10PCS
3		Flat washer:5/16"	10PCS
4		Allen wrench	1PC
5		Threaded Stud	8PCS
6		Hex Nut	8PCS
7		Half round nut	8PCS
8		Wrench	1PC
9		Screw	8PCS

STEP 1.

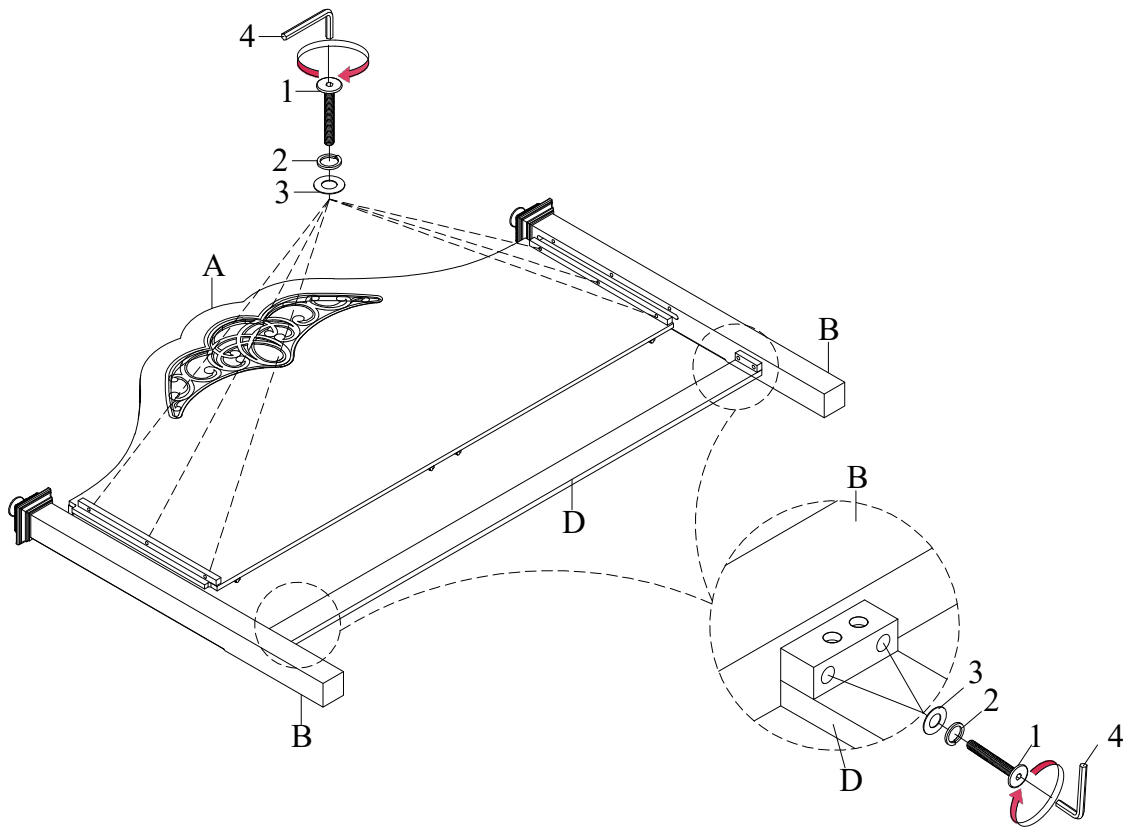

STEP 2.

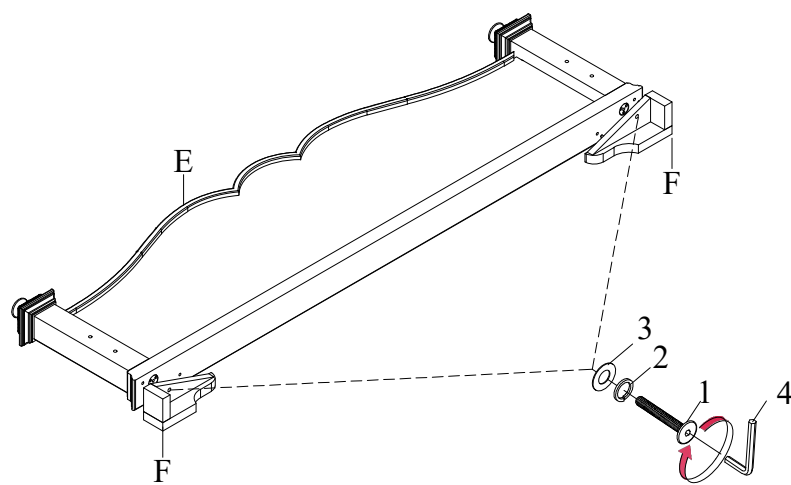

STEP 3.

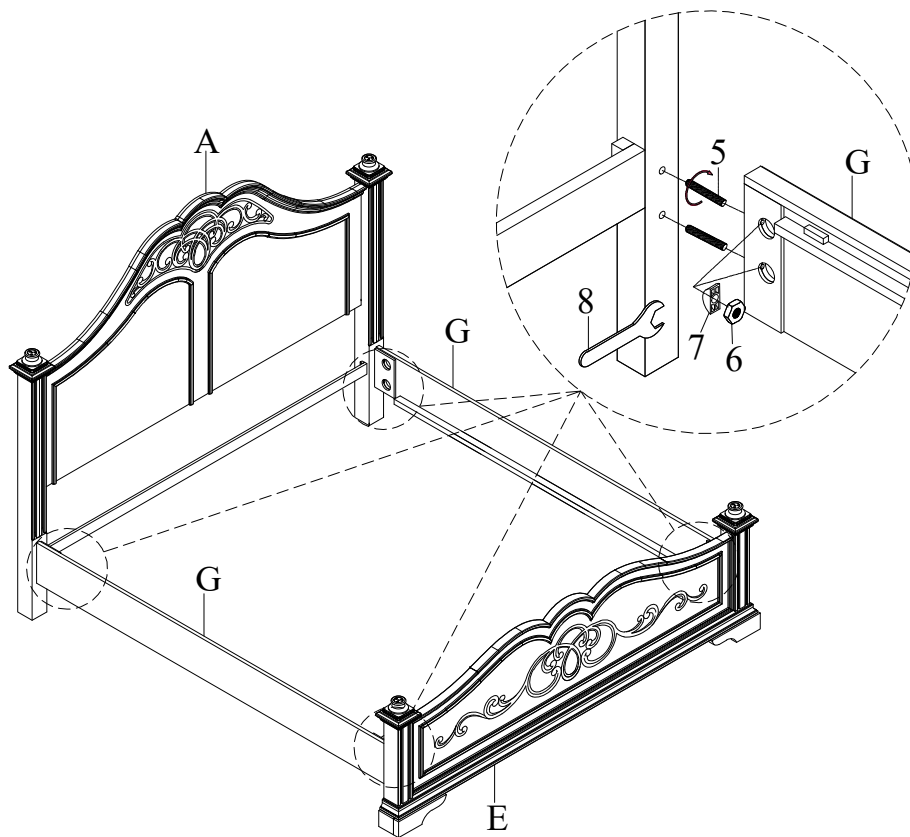

STEP 4.

