

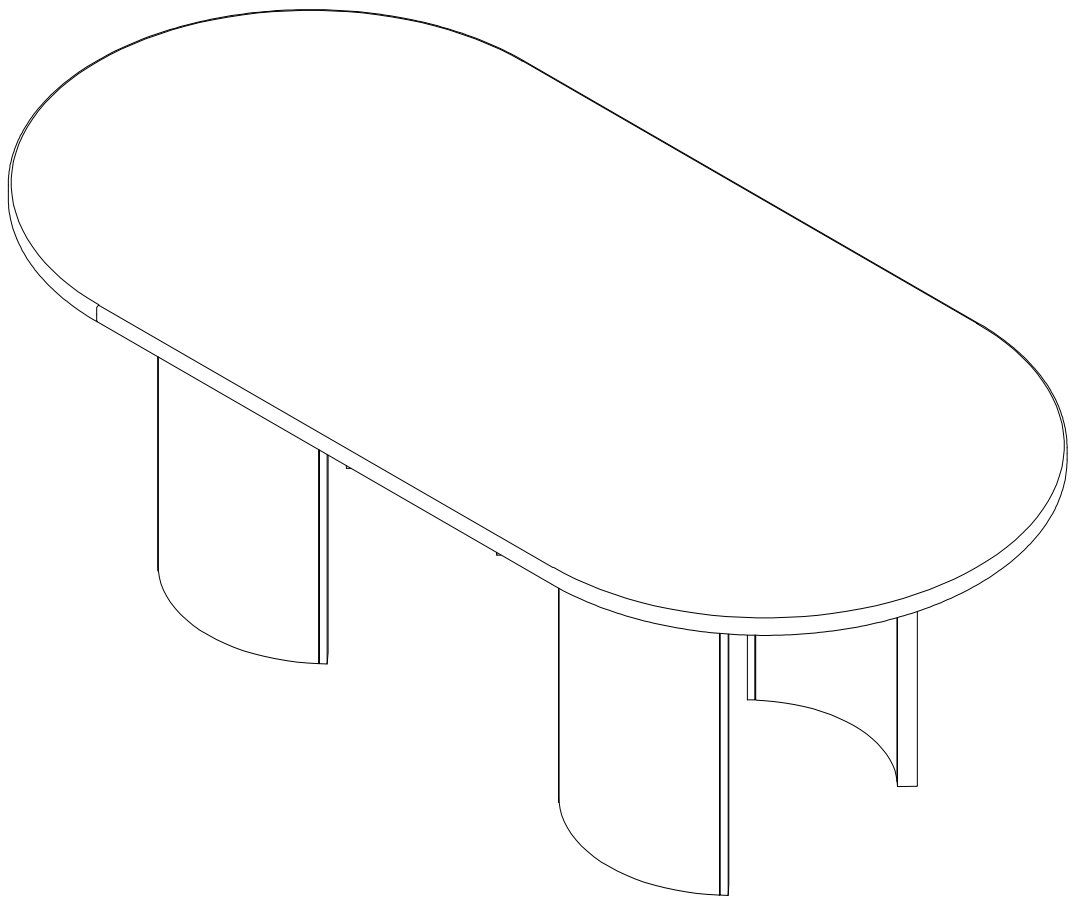

MOLLAI
COLLECTION

DV25583-DT
DINING TABLE

ASSEMBLY INSTRUCTIONS



ASSEMBLY TIPS:

- 1.Remove hardware from box and sort by size.
- 2.Please check to see that all hardware and parts are present prior to start of assembly.
- 3.Please follow attached instructions in the same sequence as numbered to assure fast & easy assembly.

Warning!







1. Don't attempt to repair or modify parts that are broken or defective. Please contact the store immediately.
2. This product is for home use only and not intended for commercial establishment.

PARTS IDENTIFICATION

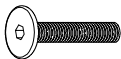
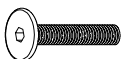
A		Table top	1 PC
B		Connect Panel	2 PCS
C		Table Legs	4 PCS

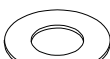
HARDWARE IDENTIFICATION

1		Bolt 5/16"*2-3/8"	24 PCS
2		Bolt 5/16"*2"	16 PCS
3		Lock Washer	40 PCS
4		Flat washer	40 PCS
5		Allen Wrench	1 PC

STEP 1.

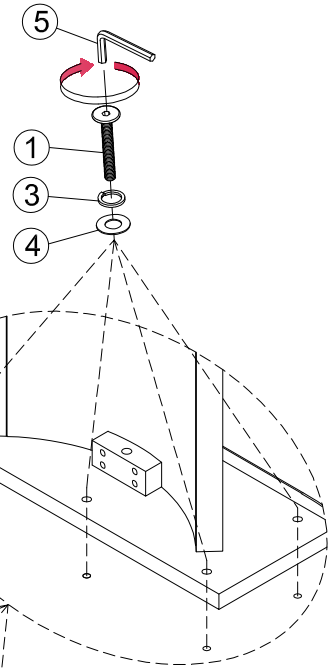
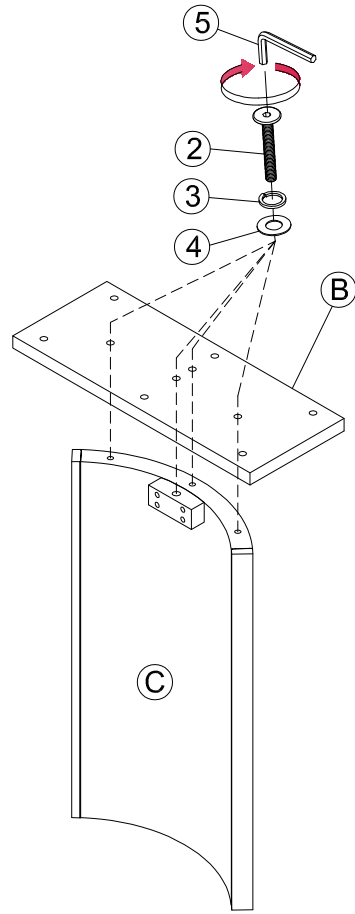

STEP 2.

